

CORRAMET®

High Impact **Corrugated Sheets** Installation Guide

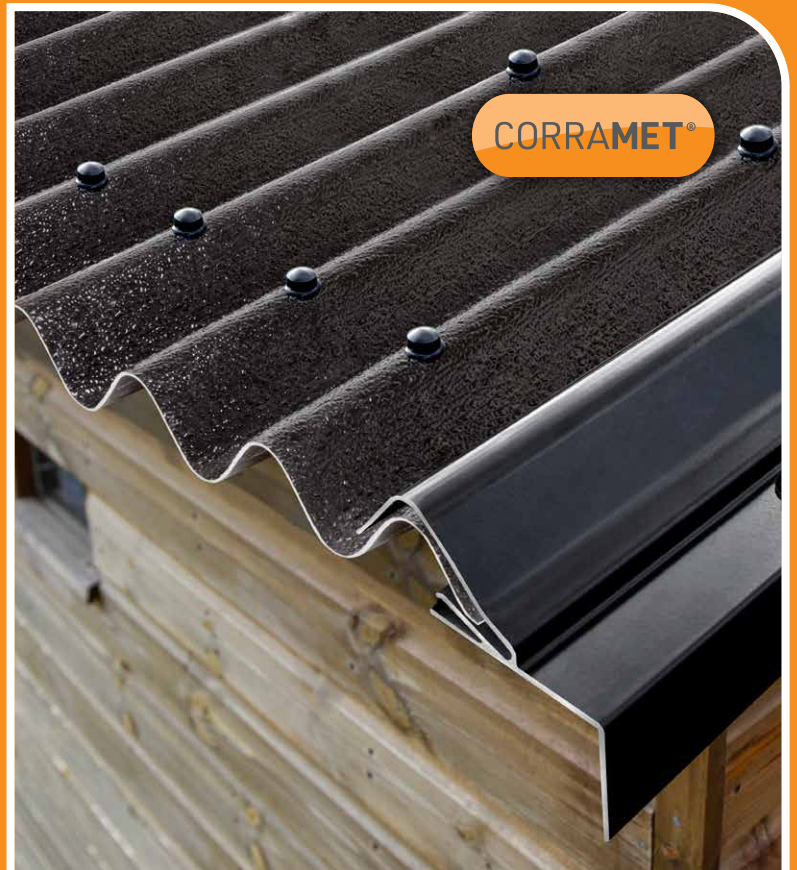

Corramet® : Installation Guide

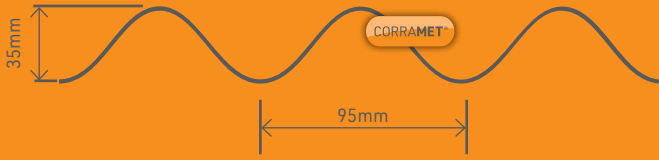

Corramet® Corrugated Sheet

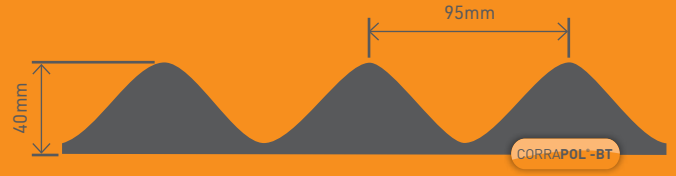

Corrapol®-BT Foam Eaves filler

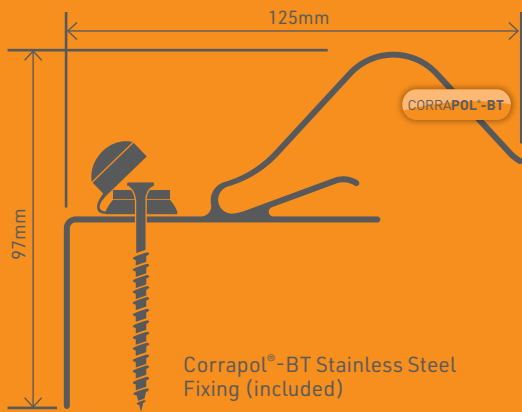

Corrapol®-BT Rock N Lock® Gable Flashing



Plastic Headed Nails



Screw Cap Fixings

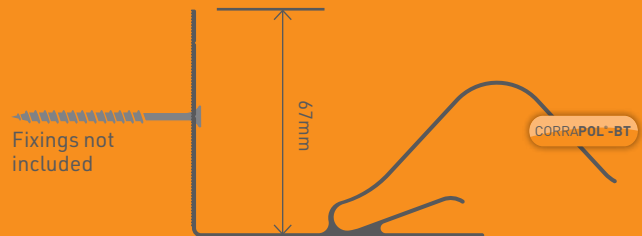

Corrapol®-BT Rock N Lock® Wall Flashing

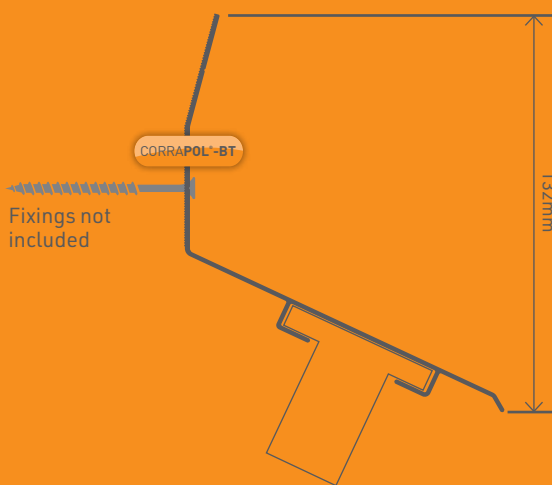

Corrapol®-BT Top Wall Flashing

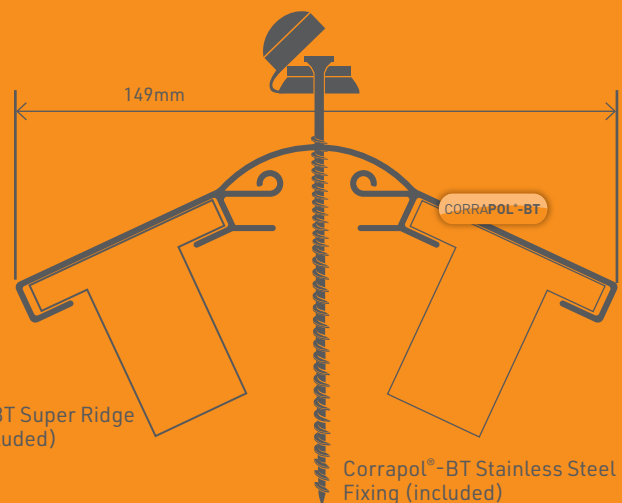

Corrapol®-BT Super Ridge Gasket (included)

Corrapol®-BT Super Ridge

Corrapol®-BT Stainless Steel Fixing (included)

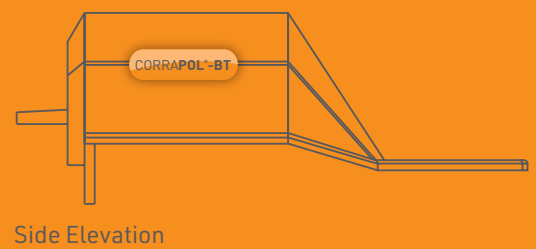
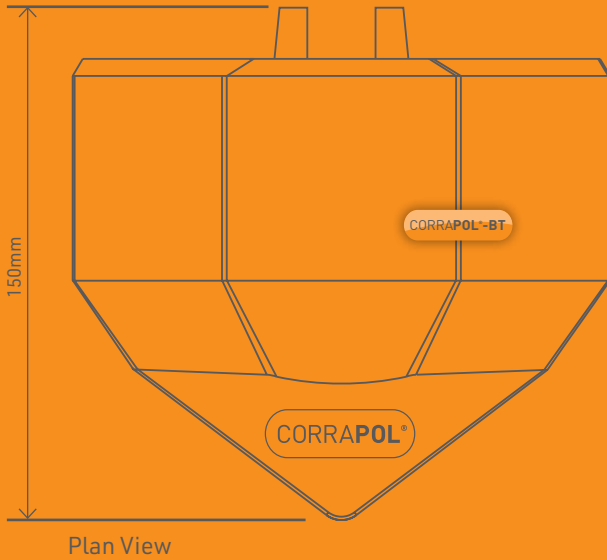

Corrapol®-BT Super Ridge End Cap

Tools required



Wear protective gloves, glasses and ear protectors where appropriate.



Clamps, fine toothed bladed hand held multi tool and tin snips.



Fine toothed bladed Chop Saw



A hammer, cordless screwdriver/drill, tape measure a straight edge tool and suitable sealant / sealant gun.

Installation

1 MEASURE the roof

IMPORTANT - Take all **MEASUREMENTS** of the roof so you can work out the correct plan for the sheet coverage. Allow an **extra 70mm overhang** on the slope length for the sheet overhang.

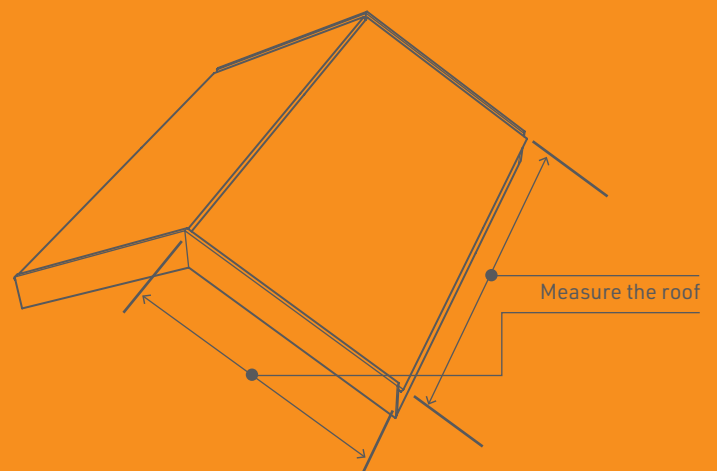

2 DETERMINE OVERLAPS for larger slopes

See diagrams below for overlap, depth and angle details

Fix intermediate roof supports every **two corrugation peaks**

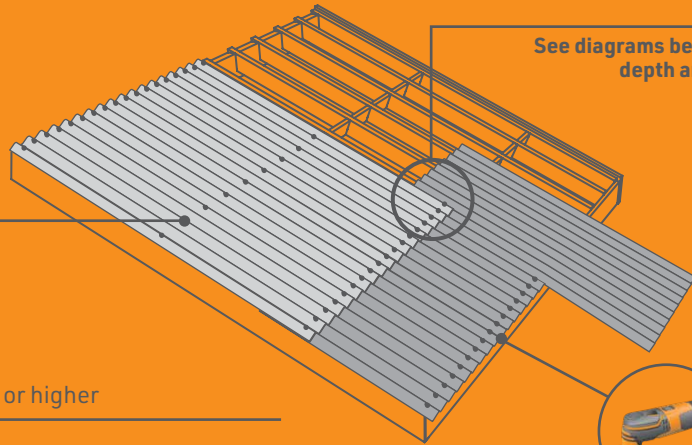

Roof slopes of 15° or greater: Gradients of 1 in 4 or higher

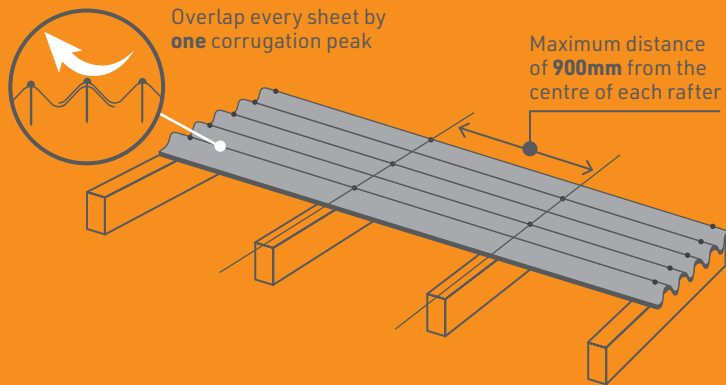

Overlapping sheets

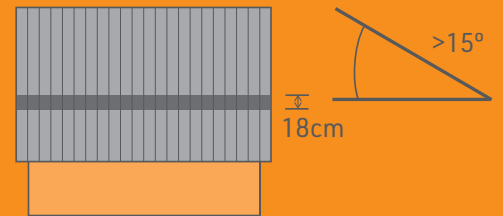

Roof slopes of 10° - 15°: Gradients of 1 in 6 - 1 in 4

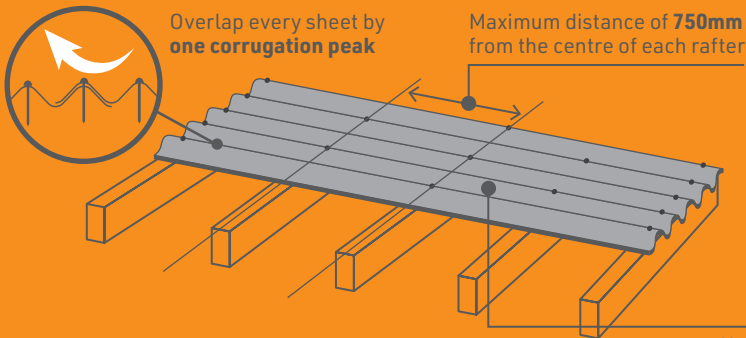

Overlapping sheets

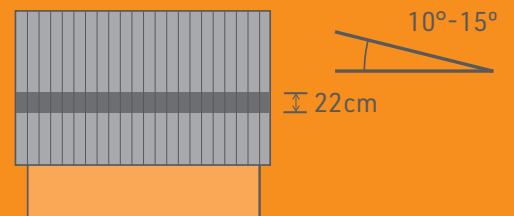

Use fixings sheets every corrugation at the eaves and sheet overlaps. Use fixings every other corrugation on intermediate purlins.

Roof slopes of 5° - 10°: Gradients of 1 in 11 - 1 in 6

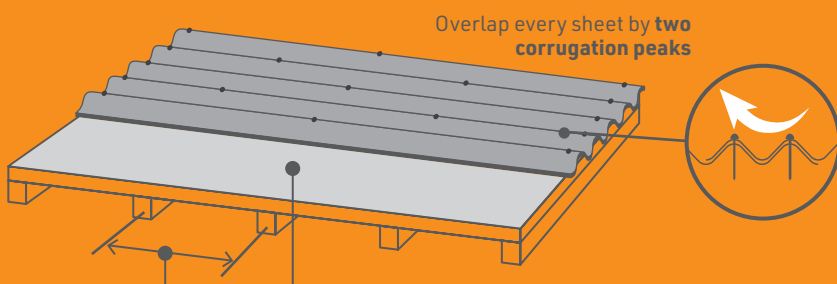

Overlapping sheets

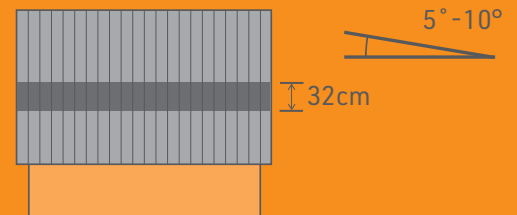

Open Rafter Spacing:
Maximum distance of **500mm** from the centre of each rafter

Fully supported timber board roof deck fitted with a waterproof membrane

3 Prepare the Corrapol®-BT Rock N Lock® Gable Flashing

Cut the **Corrapol®-BT Rock n' Lock Gable Flashing** to the required length with a chop saw which has a fine-toothed blade suitable for cutting aluminium.

Cut a **mitre** at the top end of the **Corrapol®-BT Rock N Lock® Gable Flashing** so it finishes with a vertical end when offered up to the upper end of the roof slope.

Cut the lower end of the **Corrapol®-BT Rock N Lock® Gable Flashing** to the same length as the slope, being careful to allow approximately 70mm beyond the eaves beam for an overhang.

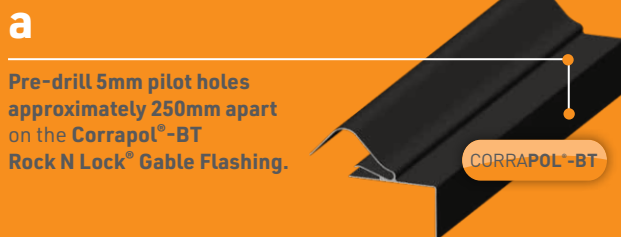
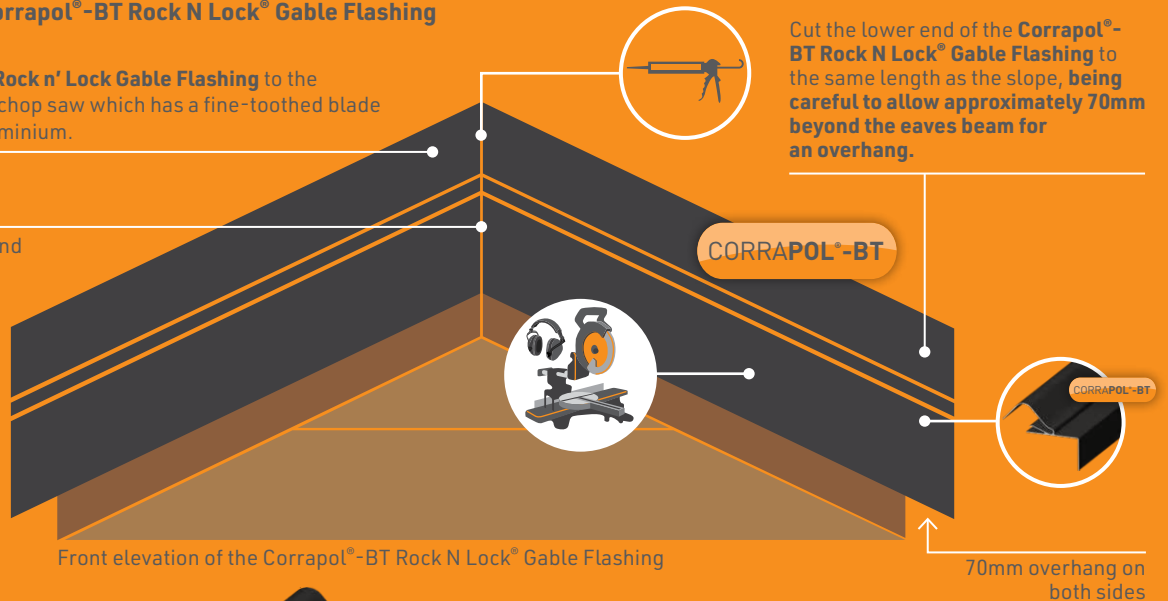

TILT the **Corrapol®-BT Rock N Lock® Gable Flashing** and ROCK the first corrugated sheet peak into the curve of the flashing.

4 Prepare the Corrapol®-BT Rock N Lock® Wall Flashing

Cut a **mitre edge** at the top end of the **Corrapol®-BT Rock N Lock® Wall Flashing** to the same lengths as the front **Corrapol®-BT Rock N Lock® Gable Flashing**.

Corrapol®-BT Rock N Lock® Wall Flashing sits directly on timber rafter.

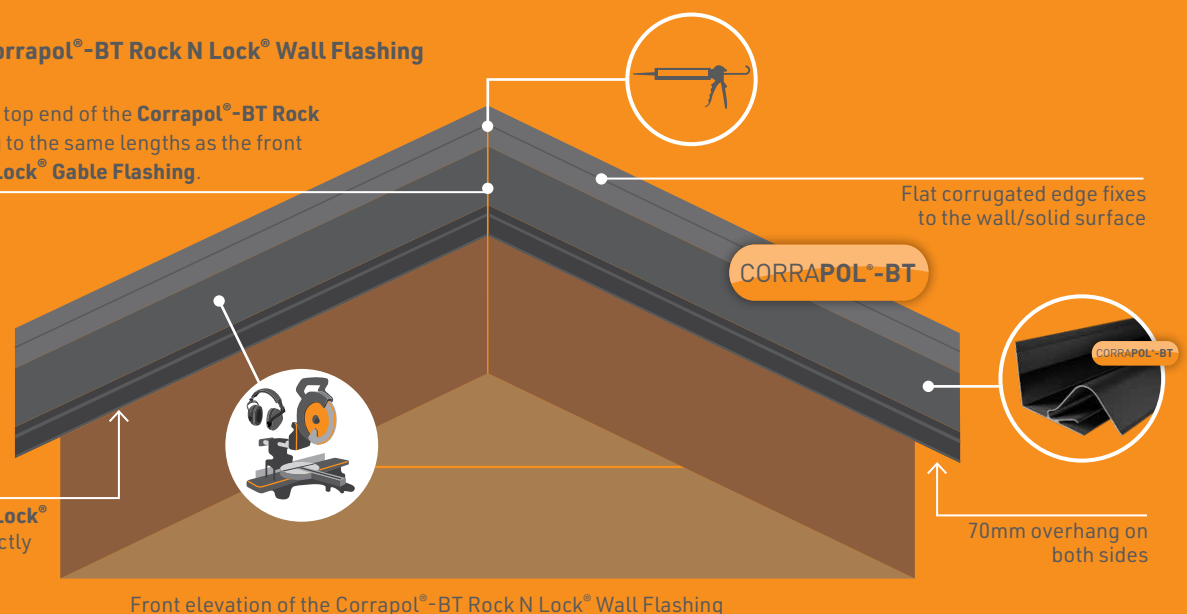

a

Pre-drill suitable sized pilot holes approximately 250mm apart for fixing the vertical back edge of the **Corrapol®-BT Rock N Lock® Wall Flashing** to the wall or solid surface. (Fixing to be supplied by installer)

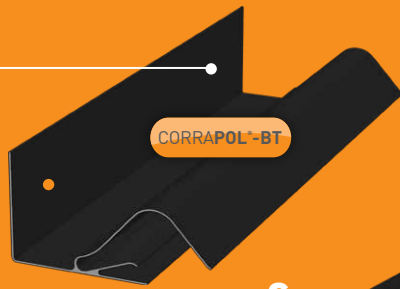

Fix the **Corrapol®-BT Rock N Lock® Wall Flashing** onto the wall using suitable stainless steel screws approximately 250mm distance between each fixing.

b

Tilt the **Corrapol®-BT Rock N Lock® Wall Flashing** to the side and fit the first corrugated sheet peak into the flashing.



c

Lock the **Corrapol®-BT Rock N Lock® Wall Flashing** into place giving a waterproof and visually pleasing finish to the wall edge of your roof structure.



5

MEASURE and **CUT** the **FIRST Corramet®** roofing sheet

Measure, mark up the new length then cut off the excess roofing sheet with a lubricated universal bladed hand held saw allowing an **overlap eave of 70mm MAX.**

Cut all the remaining corrugated sheets to the correct length before starting the installation of your roof.

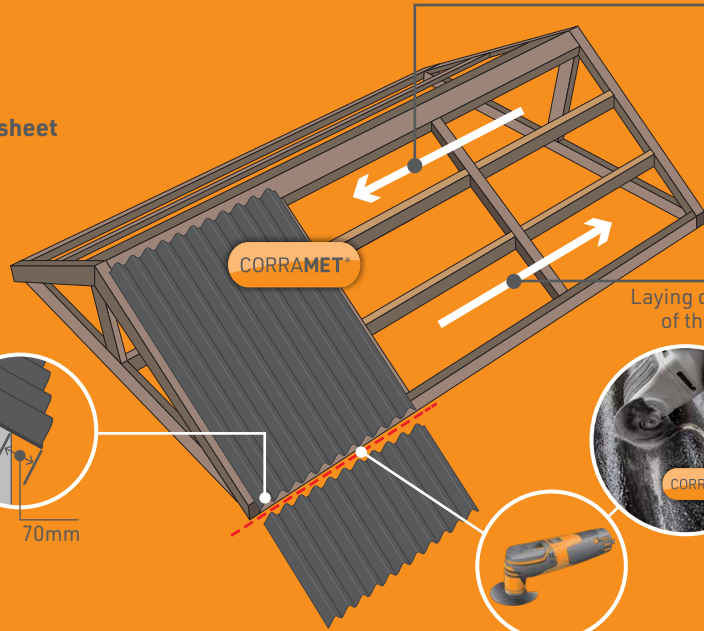

Direction of the wind

Laying direction of the sheets

View Our How 2 Cut Corrugated Plastic Sheets Video

70mm

6

Fix in place the Corrapol®-BT Foam Eaves Fillers onto every purlin

IMPORTANT - To keep the roof watertight and weatherproof, install **Corrapol®-BT Eaves Fillers** along every fixing point of the roof and **fix in place before installation of the roofing sheets.**

Make sure all the eaves fillers are aligned.

Repeat on the other side

For best performance and sealing install **Corrapol®-BT Foam Eaves Fillers** along the horizontal purlins and all fixing points of the roof. These will make installation easier, provide a stronger roof and give greater sealing properties from draughts etc.

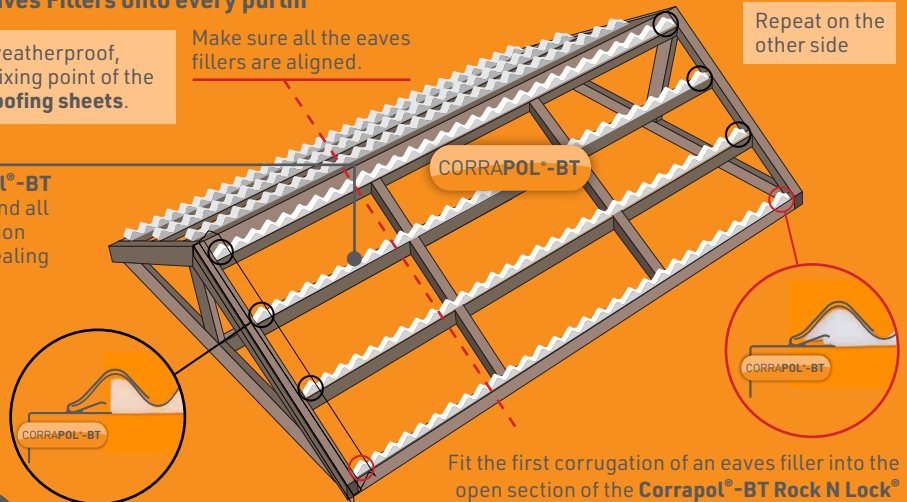

Fit the first corrugation of an eaves filler into the open section of the **Corrapol®-BT Rock N Lock® Gable Flashing** and **Corramet® Sheet** space.

7 Fit in place the **Corrapol®-BT Rock N Lock® Gable Flashing** and **FIRST Corramet® Corrugated Sheet**

TOP TIP:

Use a **long straight edge/piece of wood** to mark up where to **fix through the Corramet® sheet** and the **foam eaves filler below** into the purlin.



When fixing **Corramet® sheets**, the fixings should be **EVERY PEAK TOP AND BOTTOM** and **EVERY SECOND ON INTERMEDIATE PURLINS**.

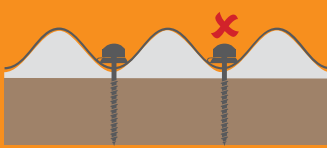

NEVER THROUGH THE TROUGH

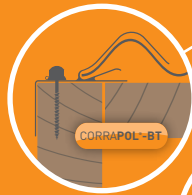

FIX EITHER through the top **OR** through the side of the bar.

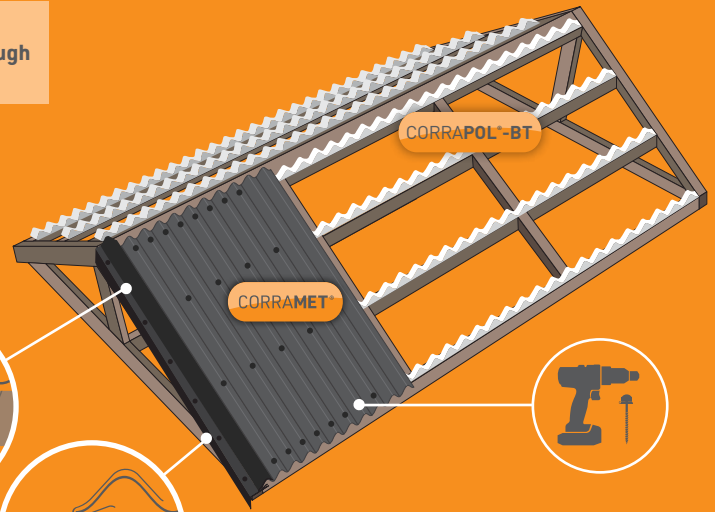
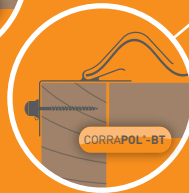

▶ [View Our How 2 Fix Corrugated Roof Sheets Video](#)

8 Prepare the **FINAL Corramet® sheets** for both sides

Using the **Corrapol®-BT Rock N Lock® Gable Flashing** you should never need to make a vertical cut as there is flexibility on the width designed into the flashing.

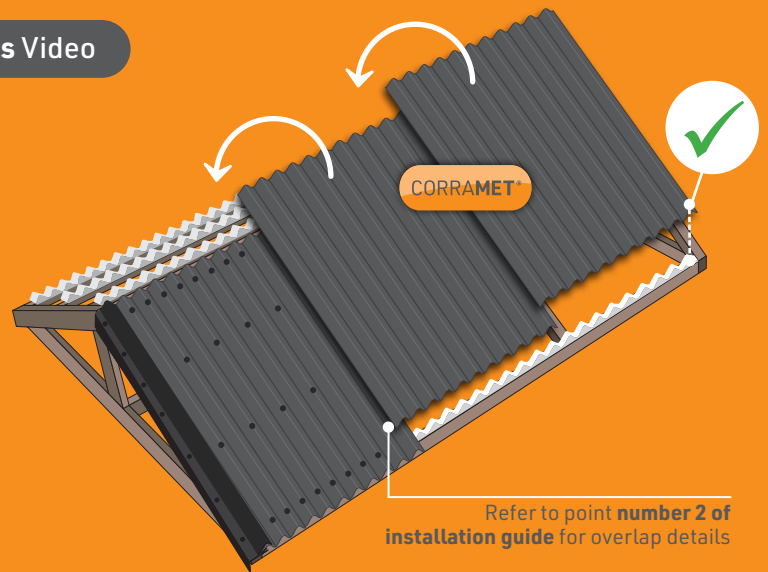

9 **Joining Sheets - end to end overlap example**

JOINING SHEETS (END TO END):

If sheets need to be joined end to end, **ensure an appropriate overlap, refer to details in Step 2.**

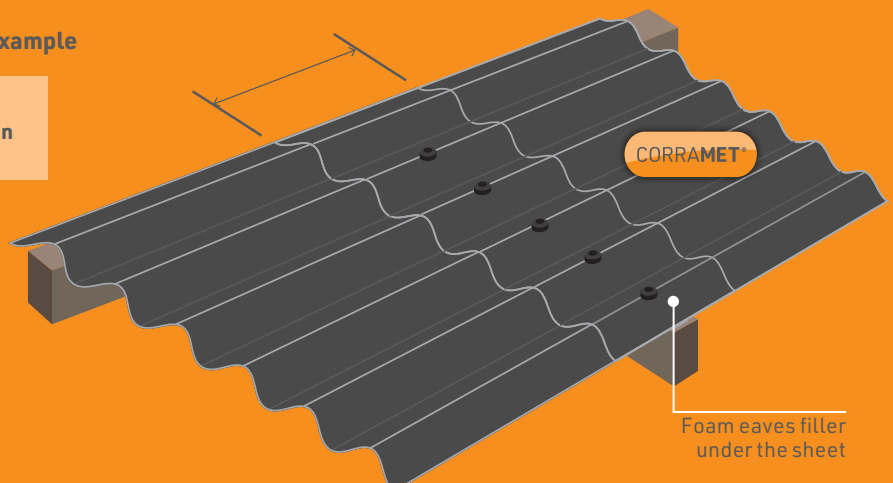

10

Fit the **Corrapol®-BT Rock N Lock® Gable Flashing** and **Corramet® Corrugated Sheets**

Fit the remaining **Corramet® Corrugated Sheets** plus **Corrapol®-BT Rock N Lock® Gable** and **Wall Flashing** as shown in parts 3 and 4.



11

Install the **Corrapol®-BT Super Ridge and End Caps**

1. **Measure and Cut** the Corrapol®-BT Super Ridge to length. This should be the distance between the inside of the Rock N Lock® flashings. Use a saw suitable metal blade.
2. **Pre-drill 5mm pilot holes** approximately 250mm apart along the ridge.
3. **Slide the Foam Gaskets** into the two side slots and place the ridge on the roof.
4. Apply **Securbond® Silicone Sealant** to the back face of the **Super Ridge End Cap** and push into place.
5. Finally, **screw the Super Ridge** into place to secure.

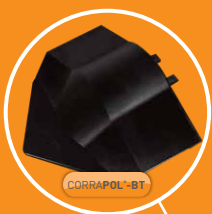

Cut the Super Ridge to the distance between the inside edges of the Rock N Lock® Flashings

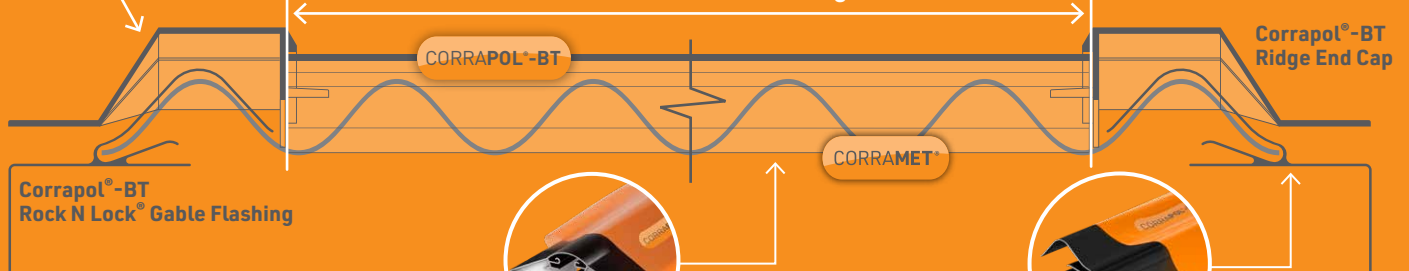

12

Finish of the back wall edge of a Lean-to roof using the **Corrapol®-BT Top Wall Flashing**



WARNING : REGISTERED DESIGNS & PATENTS

The IP of the designs in this brochure are protected by internationally registered design rights. Many products are also protected with active or pending Patents. Clear Amber will not hesitate to take appropriate legal action if its rights in this respect are infringed.

© Copyright – Clear Amber Group Ltd – October 2024 – Patented System. No part of this publication may be copied, reproduced, scanned, or stored in any electronic database, whether in whole or in part, in any form or by any means, without permission in writing from Clear Amber. Clear Amber will not hesitate to take appropriate legal action if its rights in this respect are infringed.

Inasmuch as Clear Amber have no control over the circumstances in which our material may be used, or site specific parameters, we cannot guarantee that any particular results will be achieved. Users should carry out their own tests to determine the suitability of the material for their application.